

Flange Service Tools
MATCH



HPLW18TO

HYDRAULIC
 PRECISION LIFTING WEDGE

TECHNICAL DATA SHEET

LIFTING FORCE:

700 bar hydraulic pressure give **18.0 t (180 kN)** lifting force per tool

It is advisable to use tools in pairs, resulting in a total lifting force of: $2 \times 18.0 \text{ t} = 36.0 \text{ t}$ (360 kN)

LIFTING HEIGHT:

With a Stepped Block: **9.5 mm – 59.5 mm**

KIT CONTENTS:

- 1 x Wedgehead
- 1 x 700 bar (10,000 psi) Hydraulic Cylinder
- 1 x Safety Block

Product Code	Tool
HPLW18TO	1 x HPLW18TO

RANGE OF APPLICATION:

Minimum access gap of 9.5 mm to insert the first step

HPLW18TO is marked: **CE**

WEIGHTS AND DIMENSIONS:

Tool weight: 8.5 kg (18.7 lb)
 Safety Block: 0.4 kg (0.9 lb)
 Gross Kit weight: 10 kg (22.0 lb)

Packaging Dimensions:

145 mm x 170 mm x 365 mm

STEPPED BLOCK: P/N: F0398

(Not Included): 0.75 kg (1.7 lb)

Using the Stepped Block for a **maximum spreading distance of 59.5 mm**

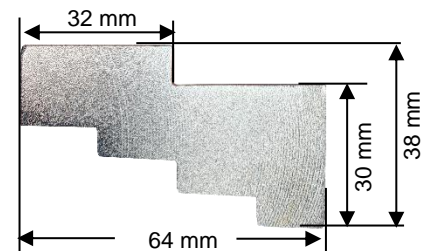
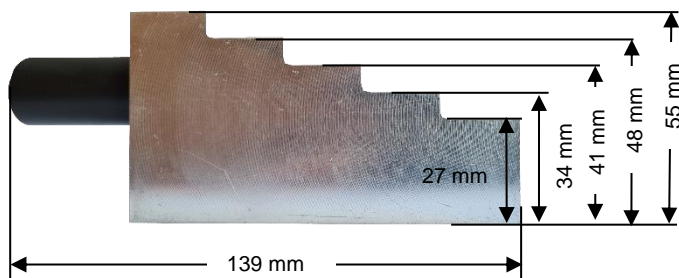

MATCH-CEE e.U.
 Flansch Service Werkzeuge und Hochdruckhydraulik
 Schlachthausgasse 30/6/13
 A-1030 Wien / ÖSTERREICH

www.flanschspreizer.at

info@flangespreader.eu

MATCH s.r.o
 Flange Service Tools
 Studena 2
 SK-82104 Bratislava / SLOVAKIA

www.flangespreader.eu

HPLW18TO

HYDRAULIC PRECISION LIFTING WEDGE



TOOL DIMENSIONS: FULLY RETRACTED

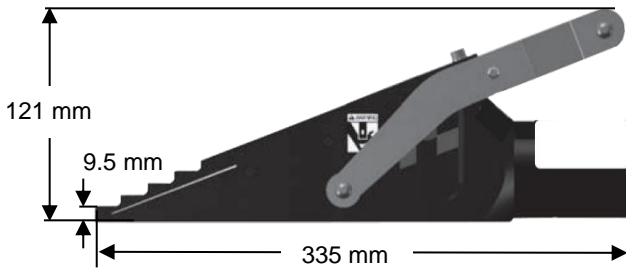

FULLY EXTENDED

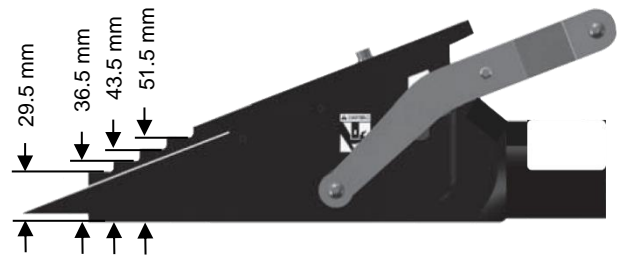
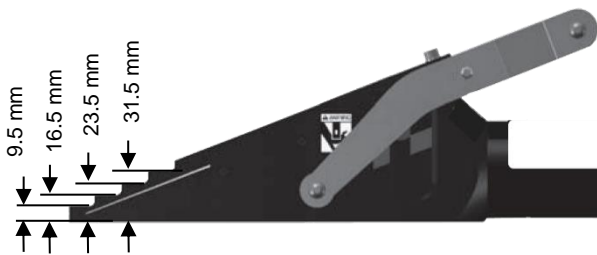
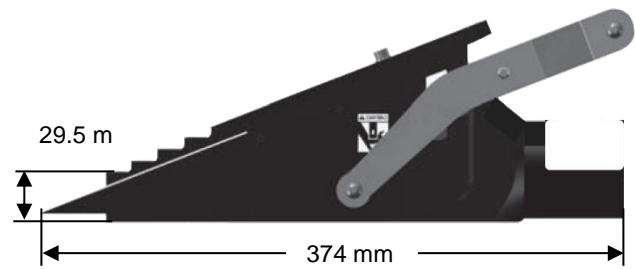

ITEM	P/N	PART NAME	QTY
1	F0393	Main Body	1
2	RC102HU	Hydraulic Cylinder	1
3	E2079	Push Pin	1
4	B1093	Slot Plug Assembly	1
5	H0375	Screw	1
6	B1135	Wedge c/w Tail Screw	1
7	H0370	Screw	1
8	F0394	Top Plate	1
9	E2081	Guide Pin	2
10	I0109	Roll Pin	4
11	J0415	Washer	1
12	H0374	Screw	1
13	J0414	Washer	2
14	C1211	Handle Left	1
15	C1212	Handle Right	1
16	G0653	Spacer	2
17	J0131	Washer	2
18	H0373	Screw	4
19	E2082	Handle Bar	1
20	G0652	Black Handle Sleeve	1
21	H0371	Grease Fitting	1
22	G0654	White Plastic Cap	2
23	H0048	Screw	2

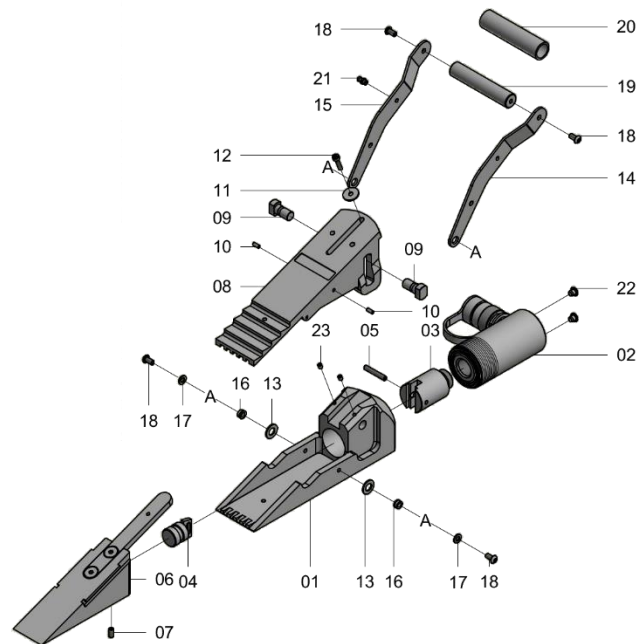

Items 4, 7, 9, 11, 12 & 22 are supplied in **Service Kit A**,
Product Code: 1501

Items 3, 5 are supplied in **Service Kit B**,
Product Code: 1502

Items 13,14,15,16,17,18,19,20 are supplied in **Service Kit C**,
Product Code: 1503

MATCH-CEE e.U.
Flansch Service Werkzeuge und Hochdruckhydraulik
Schlachthausgasse 30/6/13
A-1030 Wien / ÖSTERREICH

www.flanschspreizer.at

info@flangespreader.eu

MATCH s.r.o
Flange Service Tools
Stuđena 2
SK-82104 Bratislava / SLOVAKIA

www.flangespreader.eu