



HP550A KIT

SEALED HYDRAULIC HAND PUMP
 SINGLE PORT

HP550B KIT

SEALED HYDRAULIC HAND PUMP
 TWIN PORT

TECHNICAL DATA SHEET

2-Stage Sealed Hydraulic Hand Pump

Maximum Pressure Rating:

13.8 bar (200 psi) 1st Stage

700 bar (10,000 psi) 2nd Stage

Oil Capacity: 550 cc

Diaphragm Oil Reservoirs: Pumps are operable
 in all directions without loss of performance

Reduced risk of hydraulic fluid spillages

MATCH HP550A KIT and HP550B KIT

are marked as: **CE**

HP550A KIT CONTENTS:

- 1 x P550AEX Pump Unit
- 1 x 1,000 bar (15,000 psi) Pressure Gauge
- 1 x Quick Gauge Coupler 1/4" NPT
- 1 x Gauge Adaptor K
- 1 x Coupler 3/8" F
- 1 x HH180 Hydraulic Hose
 (1.8 m hydraulic hose c/w couplers)

HP550B KIT CONTENTS:

- 1 x P550BEX Pump Unit
- 2 x 1,000 bar (15,000 psi) Pressure Gauge
- 2 x Quick Gauge Coupler 1/4" NPT
- 2 x Gauge Adaptor K
- 2 x Coupler 3/8" F
- 2 x HH180 Hydraulic Hose
 (1.8 m hydraulic hoses c/w couplers)

Product Code

HP550A Kit

Product Code

HP550B Kit

Weights and Dimensions:	P550AEX	P550BEX
Pump Length (L)	624 mm	661 mm
Handle Length (H)	485 mm	485 mm
Pump Weight	4.8 kg (10.6 lb)	6.7 kg (14.8 lb)
Gross Kit Weight	6.2 kg (13.7 lb)	8.9 kg (19.6 lb)
Packaging Dimensions	740 mm x 190 mm x 200 mm	

MATCH-CEE e.U.
 Flansch Service Werkzeuge und Hochdruckhydraulik
 Schlachthausgasse 30/6/13
 A-1030 Wien / ÖSTERREICH

www.flanschspreizer.at

MATCH s.r.o.
 Flange Service Tools
 Studena 2
 SK-82104 Bratislava / SLOVAKIA

www.flangespreader.eu

info@flangespreader.eu

HP550A KIT

HP550B KIT

SEALED HYDRAULIC HAND PUMPS



P550AEX – SINGLE PORT PUMP DIMENSIONS:

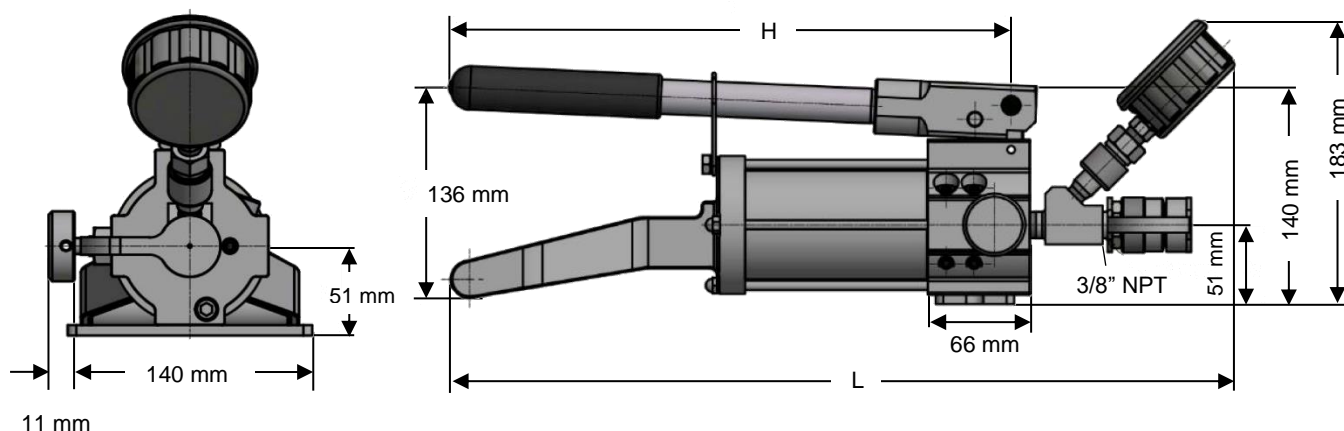

P550BEX TWIN PORT PUMP DIMENSIONS:

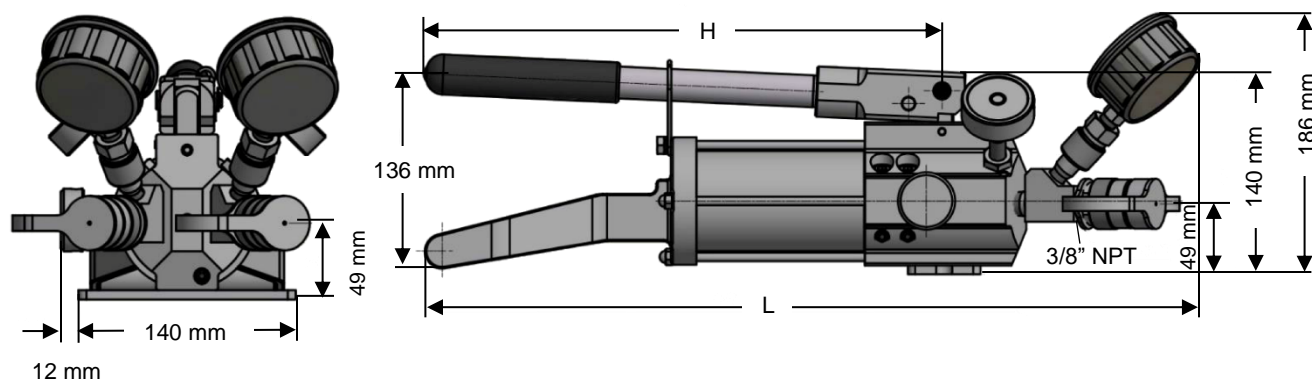

SPECIFICATIONS	STAGE	P550AEX P550BEX
Pressure Rating	1 st	13.8 bar (200 psi)
	2 nd	700 bar (10,000 psi)
Max Oil Capacity		580 cc (35.4 in ³)
Usable Oil Capacity		550 cc (33.6 in ³)
Oil Volume/Stroke	1 st	3.7 cc (0.2 in ³)
	2 nd	0.6 cc (0.04 in ³)
Max Handle Force		210 N (21 kgf)
Piston Stroke		18 mm (0.7 in)

DANGER! – PE Case and hydraulic hoses Series HHxxx cannot be used in a potentially explosive atmosphere!

Use Only ATEX certified hoses Series HHEXxxx!

MATCH-CEE e.U.
Flansch Service Werkzeuge und Hochdruckhydraulik
Schlachthausgasse 30/6/13
A-1030 Wien / ÖSTERREICH

MATCH s.r.o
Flange Service Tools
Studena 2
SK-82104 Bratislava / SLOVAKIA